

Name: _____ Date: _____ Event: _____

Track: INDOOR OUTDOOR Size: SMALL MEDIUM LARGE Traction: LOW MEDIUM HIGH

Surface: SMOOTH BUMPY RUTTED Type: LOOSE / LOAMY HARD PACKED BLUE GROOVE CLAY ASTRO

Bumpsteer/Ackerman/Servo Saver/Steering Stop: _____ Condition: DUSTY DRY WET MUDDY

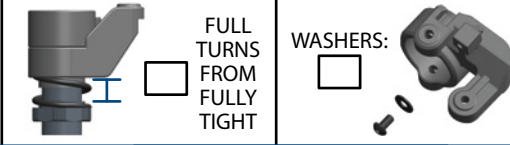
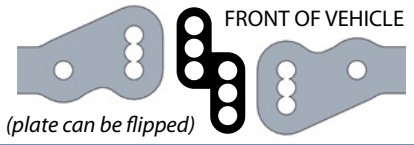
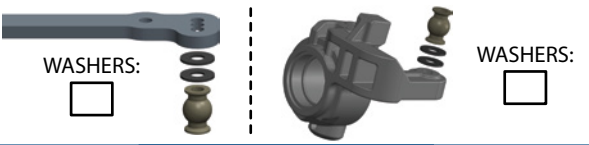

Front End:

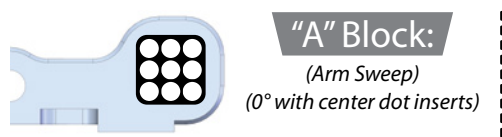
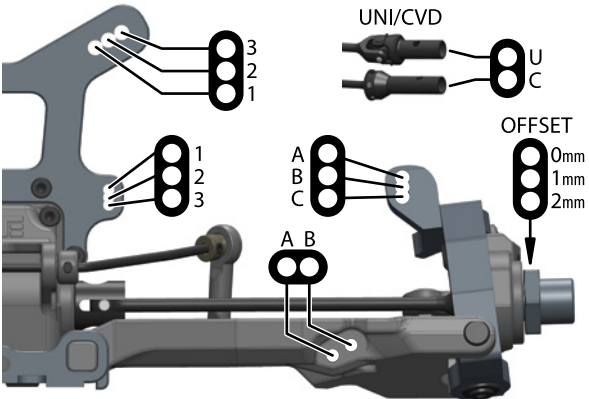

Suspension:

| | |
|---------------|---------|
| RIDE HEIGHT: | CAMBER: |
| CASTER BLOCK: | SWEEP: |
| KICK UP: | TOE: |
| SWAY BAR: | DROOP: |

| | |
|----------|---------|
| OIL: | BRAND: |
| PISTON: | SPRING: |
| REBOUND: | BUILD: |

Shocks:

Differential Oil:

| FRONT | CENTER | REAR |
|--------------------|--------|---------|
| / | / | / |
| Drivetrain: | | |
| PINION / SPUR: | / | (teeth) |
| Equipment: | | |
| ESC: | | |
| BATTERY: | | |
| MOTOR: | | |
| SERVO: | | |

Chassis Braces:

| | |
|--------------------------------------|--------------------------------------|
| CENTER DIFF: <input type="radio"/> | REAR: <input type="radio"/> |
| BATTERY INNER: <input type="radio"/> | BATTERY OUTER: <input type="radio"/> |

Tires / Wheels:

| |
|----------------|
| BRAND / TREAD: |
| COMPOUND: |
| INSERT: |
| WHEEL: |
| NOTES: |

Body / Wing:

| |
|------------|
| BODY MAKE: |
| WING MAKE: |

Notes:

Rear End:

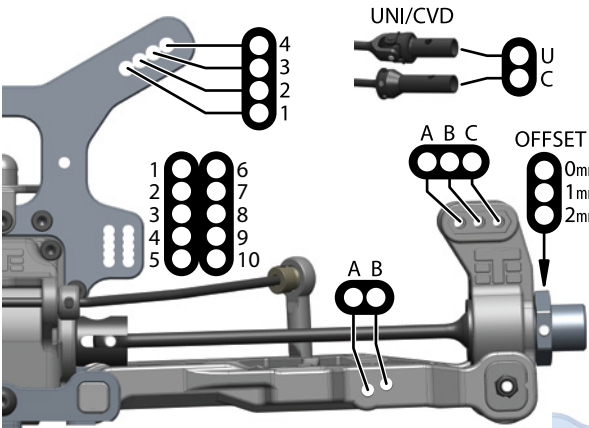

Suspension:

| | |
|--------------|---------|
| RIDE HEIGHT: | CAMBER: |
| ANTI-SQUAT: | TOE: |
| SWAY BAR: | DROOP: |

| | |
|----------|---------|
| OIL: | BRAND: |
| PISTON: | SPRING: |
| REBOUND: | BUILD: |

Shocks:

Arm Inserts:

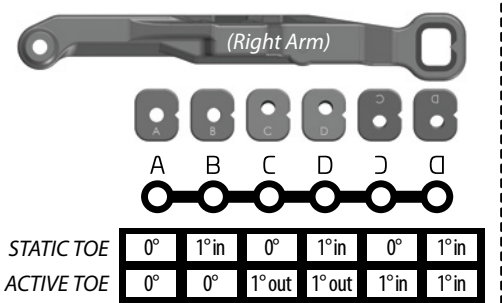

Rear Hub / Wheelbase:

